

DESCRIPTION

This class AB GaN module is designed for both military and commercial applications. It is capable of supporting any signal type and modulation format, including but not limited to 3-4G telecom, WLAN, OFDM, DVB, and CW/AM/FM. The latest device technologies and design methods are employed to offer high power density, efficiency, and linearity in a small, lightweight package.

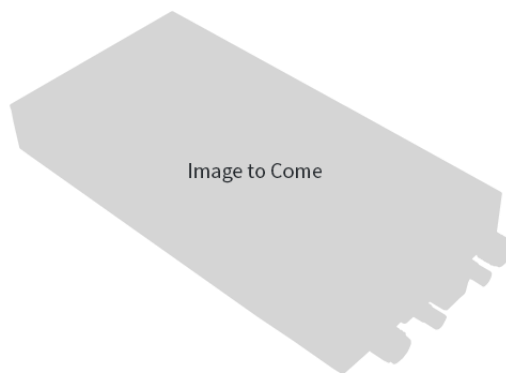

FEATURES

- Over / Under / Reverse Voltage Protection
- Over-Temperature Protection
- Optional Heatsink
- Tx / Rx Status Monitor
- Forward Power Measurement
- Temp. Monitor Output
- Manual or Automatic Tx/Rx Switching Available

Specifications subject to change without notice. Typical performance at +12VDC at 25°C in a 50Ω system

TX SPECIFICATIONS (PER CHANNEL)				
PARAMETER	MIN	TYP.	MAX	UNIT
Operating Frequency	4400		4700	MHz
PSat Power Output		+50.0		dBm
Gain		25.0		dB
Gain Flatness		1.0		± dB
Input Return Loss	-15			dB
Operating Voltage	+10	+12	+14	VDC
Tx / Rx Switching Time		1.0	2.0	uS

RX SPECIFICATIONS (PER CHANNEL)				
PARAMETER	MIN	TYP.	MAX	UNIT
P1dB Power Output		+5.0		dBm
Gain		10.0		dB
Gain Flatness			1.0	± dB
Noise Figure		2.5		dB
OIP3		+15.0		dBm
Input Return Loss	-10			dB
Current Draw		100.0		mA

MECHANICAL		
PARAMETER	VALUE	UNIT
Dimensions (L x W x H)	0 x 0 x 0	in
RF Connectors (Input / Output)	SMA-F / SMA-F	--
DC / Control Connector	21 Pin Micro-D	--
Cooling	Baseplate Conduction - Optional Heatsink Available	--
Mounting	4-40 Thru Holes	--
Weight	0	oz.
Weight With Heatsink	0	oz.

ENVIRONMENTAL / PROTECTIONS			
PARAMETER	MIN	MAX	UNIT
Operating Temp. (Housing Temp.)	-40	+85	°C
Humidity Range	0-95		%
Altitude	0-30,000		ft.
Shock / Vibration	MIL-STD-810 and equivalents		--
Max RF Input (Per Channel)	+17		dBm
PA Baseplate Shutoff Temperature	+85		°C

DC / CONTROL PINS		
AMPLIFIER CONNECTOR TYPE:		21 PIN MICRO-D FEMALE
TRIAD CABLE PART NUMBER:		CBL45
PIN LABEL	NAME	DESCRIPTION
1-3,12-13	+VDC	Supply Voltage - Range Specified in Datasheet
4	FWD DET	Tx Amp RMS Power Detector
5	TEMP	Temp Monitor: Temp in DegC = (Vout - 0.5V) * 100
6	RAD DET	Radio Input RMS Power Detector
9-11,20-21	GND	+VDC Supply Return
7	Status	BDA Status - TTL High = Normal Operation, TTL Low = Error Condition
8	Tx/Rx	TTL High or No Connection = Tx, TTL Low = Rx
19	SGND	Signal Ground
14-18	Reserved	Reserved for future use

802-11G (20 MHz BW) DATA RATE VS. OUTPUT POWER (PER CHANNEL)			
OFDM MODULATION	DATA RATE	POUT (W) MIN.	EVM
64QAM	54 Mbps	20	≤ -27 dB
16QAM	36 Mbps		≤ -21 dB
QPSK	12 Mbps		≤ -15 dB
BPSK	9 Mbps	100	≤ -7 dB

See our [application note](#) that describes how this table was calculated and provides notes on in-system performance

High-Level Block Diagram

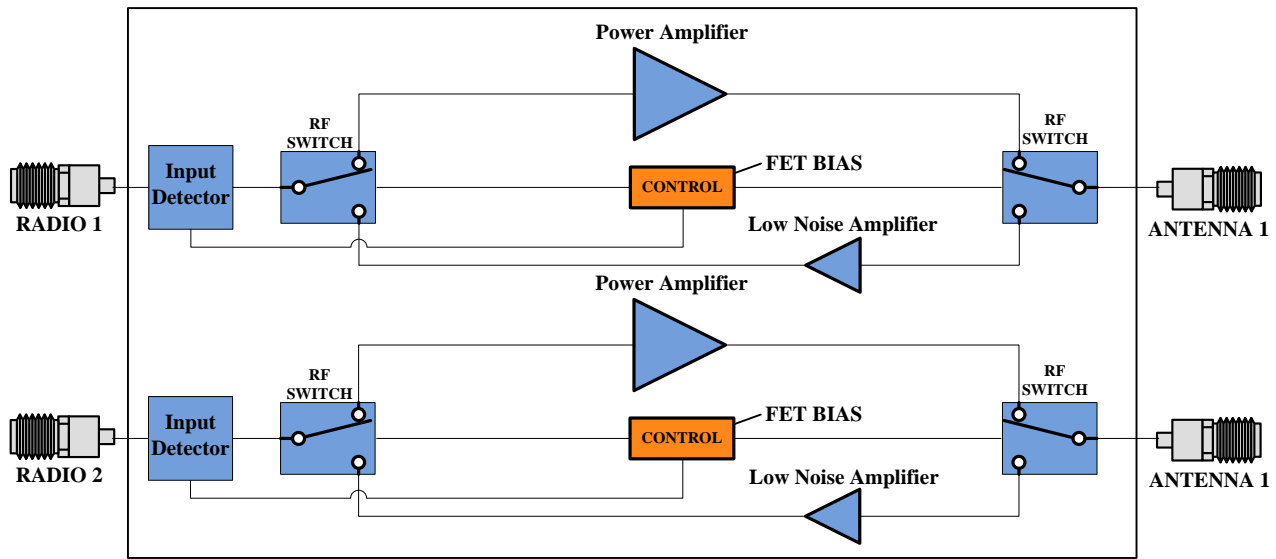

Ordering Guide – Configuration Information		
Model Number	Amplifier Option	Heat Sink Option
TTRMXXXXD	- XXX	- XXX

Amplifier Options		Heat Sink Options	
Suffix	Description	Suffix	Description
D01	Automatic Tx/Rx Switching	(none)	No Heat Sink Included
D02	Manual Tx/Rx Switching	HS	Standard Heat Sink
DXX	Custom Amplifier Configuration (issued by Triad upon customer request)	HSF	Heat Sink with Integrated Cooling Fan
		HSX	Custom Heat Sink Configuration