

DESCRIPTION

This class A GaAs module is designed for both military and commercial applications. It is capable of supporting any signal type and modulation format, including but not limited to 3-4G telecom, WLAN, OFDM, DVB, and CW/AM/FM. The latest device technologies and design methods are employed to offer high power density, efficiency, and linearity in a small, lightweight package.



FEATURES

Over / Under / Reverse Voltage Protection
Reflected Power Measurement
Temperature Output

Forward Power Measurement
High Speed On/Off Control
Optional Heatsink

Specifications subject to change without notice. Typical performance at +12VDC +25°C, and in a 50Ω system.

RF / ELECTRICAL				
PARAMETER	MIN	TYP.	MAX	UNIT
Operating Frequency	2500		2700	MHz
P1dB Power Output		+44.0		dBm
Gain	44.0	45.0		dB
Gain Flatness		1.0	1.5	dB ¹
Input Return Loss	-16	-18		dB
Operating Voltage	+11	+12	+13	VDC
Current Draw		7.0	8.0	A
Quiescent Current Draw		7.0		A
Switching Time		1.0	2.0	uS

1 – Gain flatness recorded represents a peak-peak measurement across the **entire operating band**. Gain flatness is typically much lower across significant portions of this band. Consult the gain response plots for details if available.

MECHANICAL

PARAMETER	VALUE	UNIT
Dimensions (L x W x H)	5 x 2.5 x 0.553	in
RF Connectors (Input / Output)	SMA-F / SMA-F	--
DC / Control Connector	Circular Locking	--
Cooling	Baseplate Conduction - Optional Heatsink Available	--
Mounting	4-40 Thru Holes	--
Weight	7	oz.
Weight with Heatsink	17	oz.

ENVIRONMENTAL / PROTECTIONS

PARAMETER	MIN	MAX	UNIT
Operating Temp. (Housing Temp.)	-40	+85	°C
Humidity Range	0-100		%
Altitude	0-30,000		ft.
Shock / Vibration	MIL-STD-810 and equivalents		--
Max RF Input	+2		dBm
PA Baseplate Shutoff Temperature	+ 90		°C

INPUT/OUTPUT PINS

AMPLIFIER CONNECTOR TYPE:		CIRCULAR PUSH/PULL MALE
TRIAD CABLE PART NUMBER:		CBL12
PIN NUMBER	LABEL	DESCRIPTION
1	GND	Ground
2	TEMP	Temp Monitor: Temp in DegC = (Vout - 0.5V) *100
3	Amp Enable	TTL Hi or No Connection = Enable, TTL Lo = Disable
4	FWD	Forward Power Detection
5	REV	Reverse Power Detection
6	+VDC	Supply Voltage - Range Specified in Datasheet

Configuration Options

Model Number	Description
TA1087	No Heat Sink Included
TA1087 – HS	Standard Heat Sink
TA1087 – HSF	Heat Sink with Integrated Cooling Fan
TA1087 – HSX	Custom Heat Sink Configuration
TA1087 – DOX	Custom Amplifier Configuration (issued by Triad upon customer request)

REVISIONS			
REV	DESCRIPTION	DATE	APPROVED
0	INITIAL RELEASE	7/25/14	DMC
1	E18227	6/6/18	SC

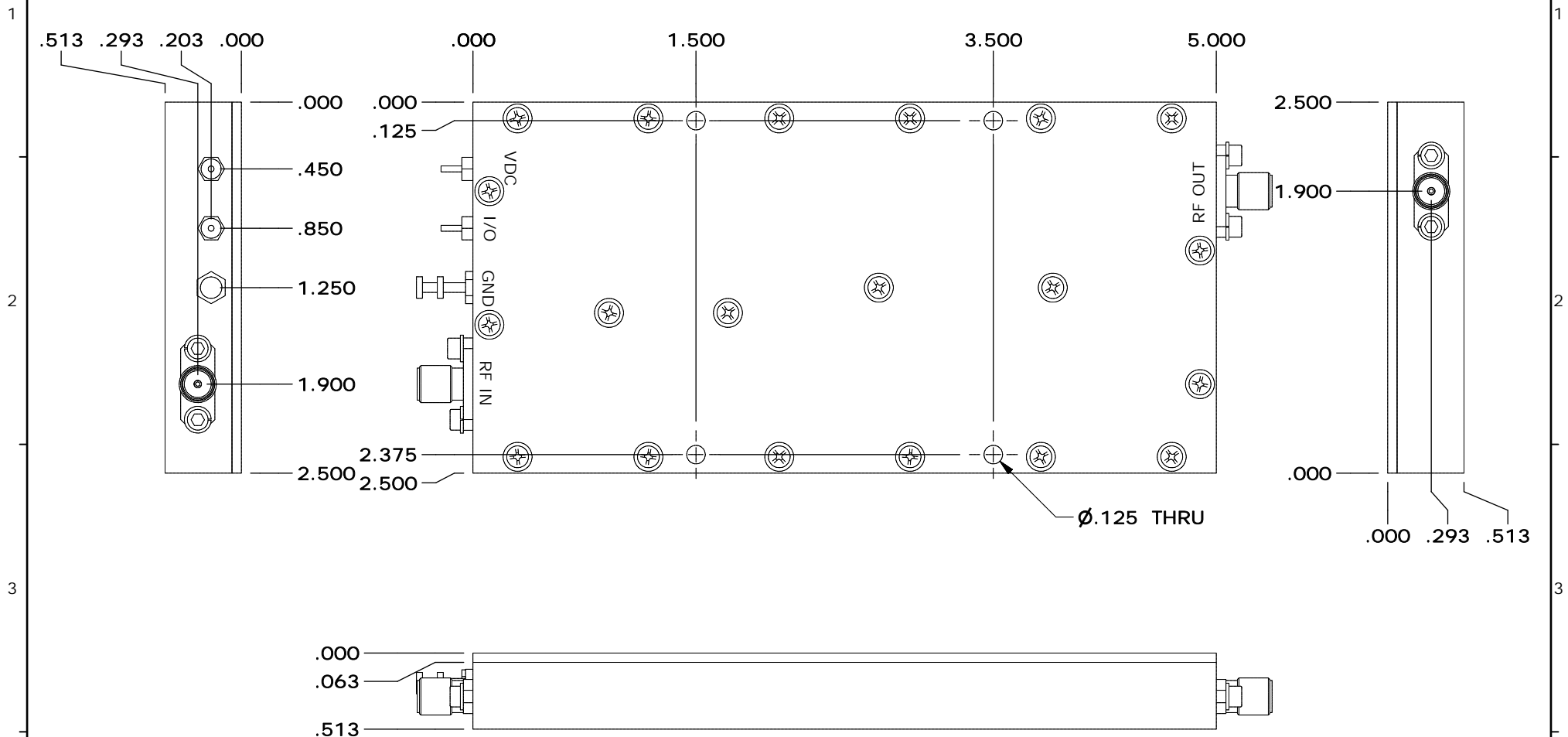

DRAWN	DMC	5/27/2015
DESIGNED	DMC	5/11/2012
CHECKED		
ENG APPROVED		
MFG APPROVED		



11 HARTS LANE SUITE I
EAST BRUNSWICK, NJ 08816
855-558-1001

HOUSING OUTLINE DRAWING 101

DIMENSIONS ARE IN INCHES UNLESS SPECIFIED OTHERWISE TOLERANCES		SIZE	DWG NO.	REV
DECIMALS	FRACTIONS	ANGLES	A	1
XX ±.01	± 1/32	± 2°	OL_101	
.XXX ±.005			SCALE: NONE	CAGE CODE 67DZ3
			SHEET 1 OF 2	

HEATSINK

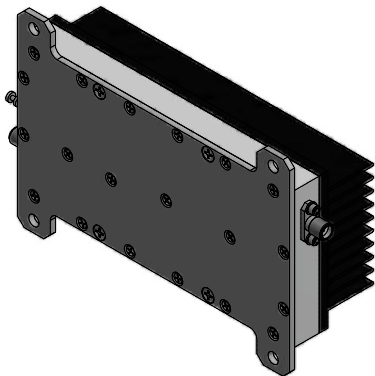
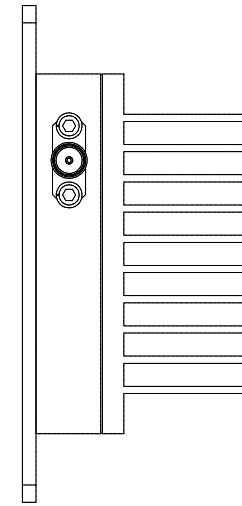
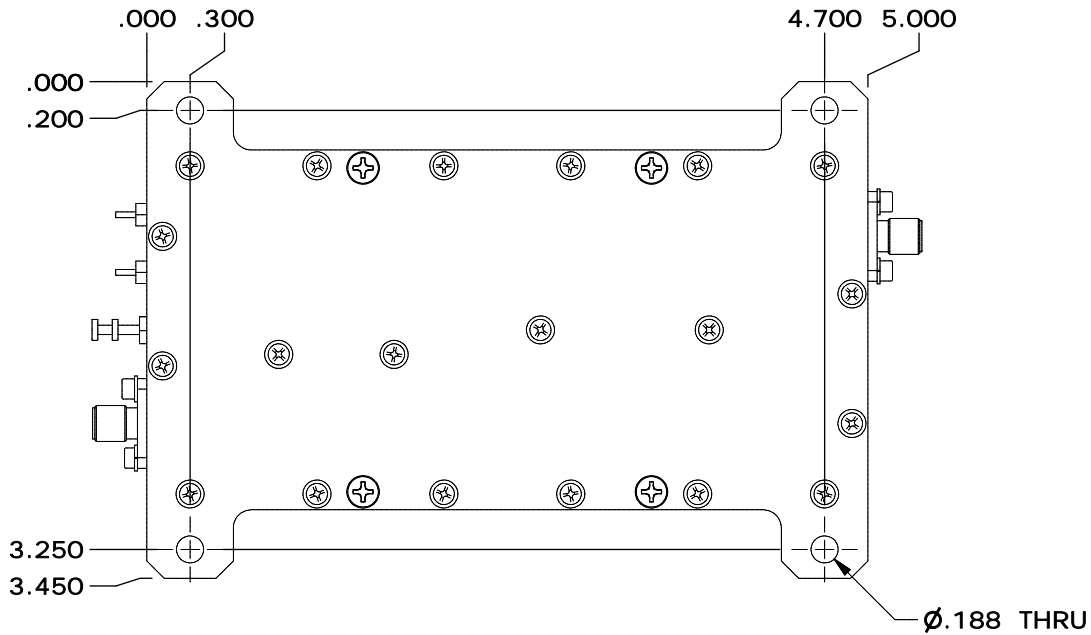
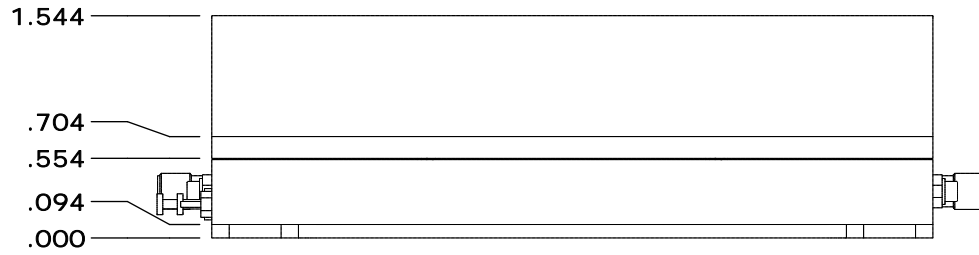

DRAWN	DMC	5/27/2015	HOUSING OUTLINE DRAWING 101		
DESIGNED	DMC	5/11/2012	SIZE	DWG NO.	REV
CHECKED			A	OL_101	1
ENG APPROVED			SCALE: NONE	CAGE CODE 67DZ3	SHEET 2 OF 2
MFG APPROVED					